

HYDRODYNAMIC MEASUREMENTS AROUND MOVING BODIES

Mathias Samson

P' Institute, CNRS- University of Poitiers - ENSMA, UPR 3346, France

INTRODUCTION: This applied session will proceed in the Pprime Institute of Poitiers. This Institute is a research unit whose topics are Physics and Mechanics of Materials, Fluid-Thermal-Combustion, Mechanical Engineering and Complex Systems. These issues are addressed through experimentation, numerical simulation and theoretical modeling. Within this Institute are grouped two axes, RoBioSS and HydEE, which respectively investigate the biomechanics of sports and the hydrodynamics of flows. It is at the crossroads of these two teams that are located this applied session entitled "Hydrodynamic measurements around moving bodies". The objective of this session is to present kinematic and dynamic measuring tools to analyse the flow around a solid in motion, especially around the arms of swimmer, in front crawl.

SHORT SUMMARY: This session will be organized in several stages. The first is a general presentation that will introduce the research activities of the institute and of the two groups involved in this session. In the second part, two contributions directly linked to the measurements around moving bodies will be discussed.

Contribution 1 (Mathias Samson, Dr Tony Monnet): Kinematic and dynamic coupled measurements in tethered front crawl swimming. Fully tethered swimming is a tool often used to measure the performance level of swimmers and also as a training resource. It aims to simultaneously measure propulsive forces and kinematic parameters created by the arms, at different paces swimming in front crawl.

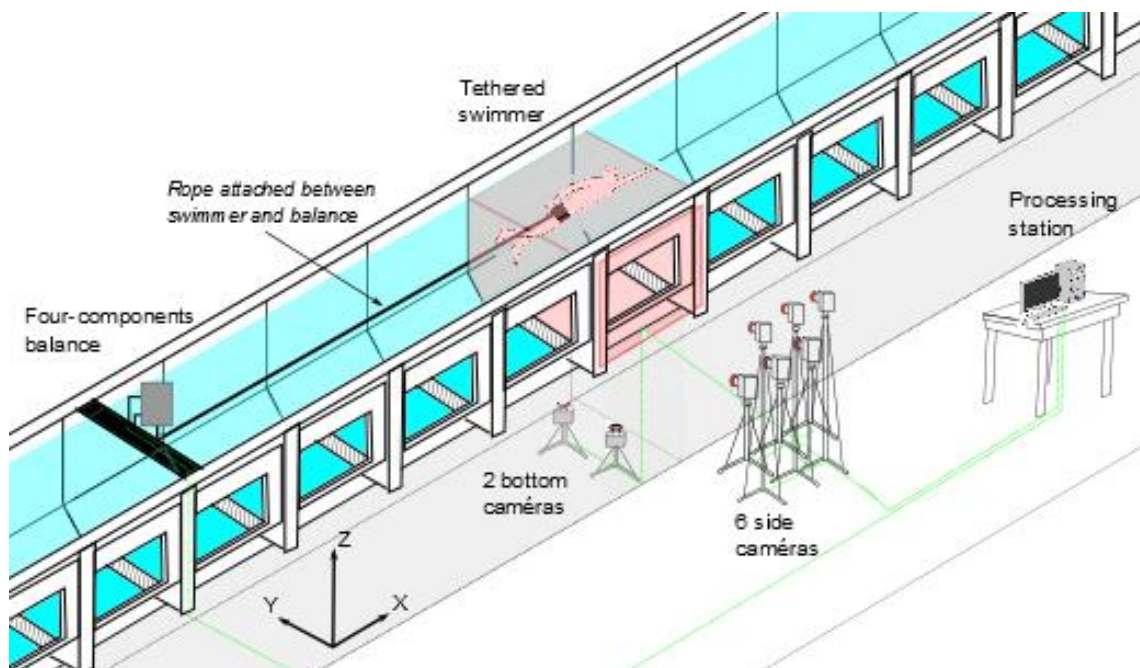

(a)

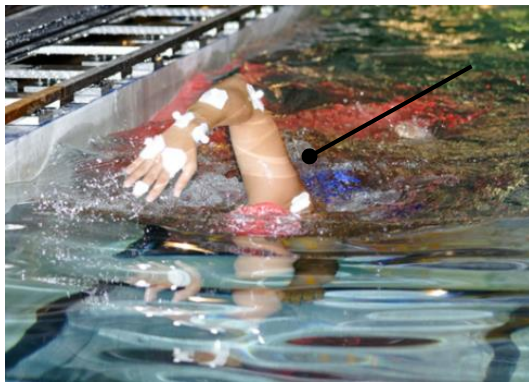

(b)



(c)

Measurement systems of tethered swimming: optoelectronic kinematic system coupled with piezoelectric balance. **(a)** Measurement systems of the hydrodynamic channel; **(b)** Tethered swimmer; **(c)** Side view through the window.

Contribution 2 (Pr. Laurent David and Dr Anthony Bernard): Hydrodynamic measurements around moving profiles: flapping flight, water turbine, and oscillating profile.

Different experimental devices and measurement techniques will be presented in the context of the flow analysis around moving profiles. Direct dynamic measurements like loads, torque or pressure are often coupled with kinematic measurement like velocity. Optical non-intrusive measurements are developed in the lab and allow accurate and local measurements of the flow around profiles.

Three examples will be presented:

- A flapping wing in hover
- A vertical axis water turbine
- An oscillating profile at high Reynolds number.

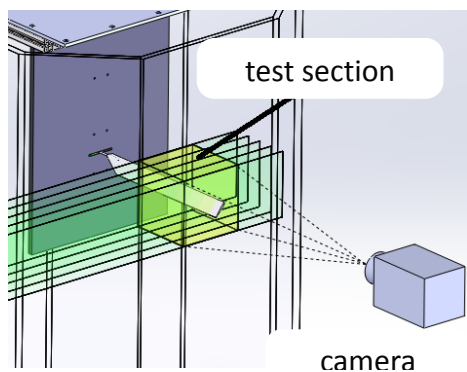

(a)

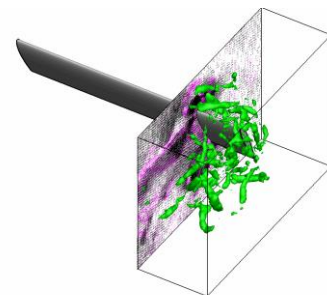

(b)

(a) Acquisition of the flow around a flapping wing; **(b)** Landa 2 criterium, pressure and velocity measurements from TR PIV.

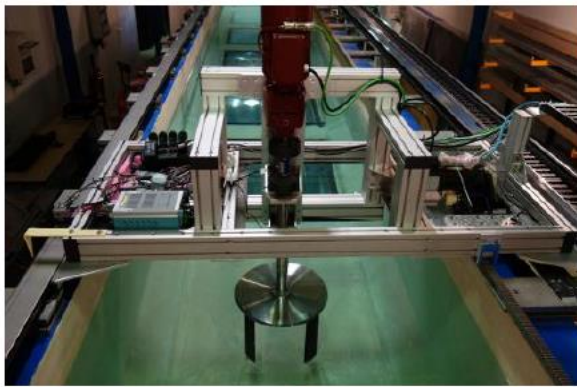

(a)

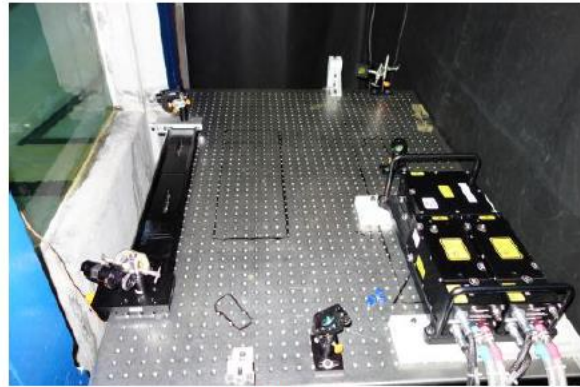

(b)



(c)

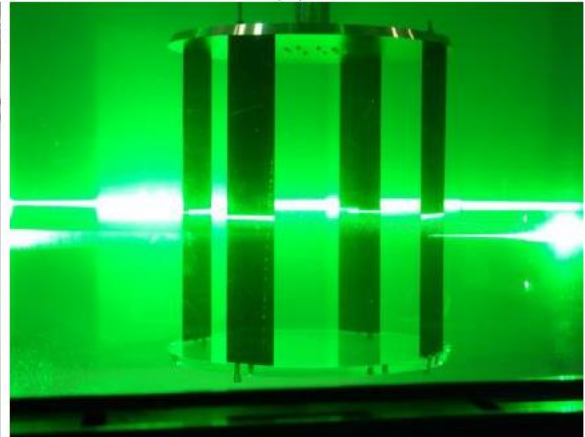

(d)

(a) Turbine model in the starting zone of the towing tank; **(b)** Optical arrangement for laser beam separation; **(c)** CCD cameras; **(d)** Instantaneous laser sheet on the mid-plane of the turbine.

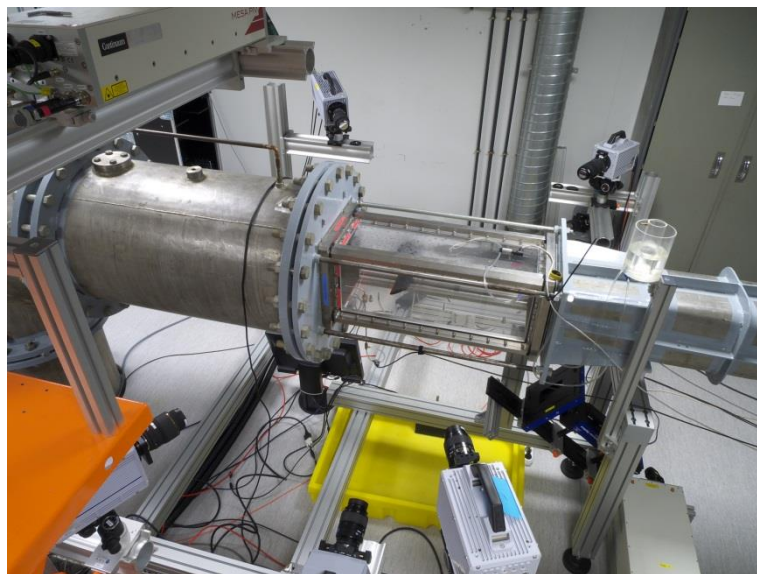

Simultaneous TomoPIV-pressure measurements of the flow around an oscillating wing with six cameras